

TABLE OF CONTENTS

CTXA-AS/AT/AW, FTXA-AS/AT/AW

1	Features	2
	CTXA-AW	2
	CTXA-AS	3
	CTXA-AT	4
	FTXA-AW	5
	FTXA-AS	6
	FTXA-AT	7
2	Specifications	8
	Technical Specifications	8
	Technical Specifications	9
	Technical Specifications	11
	Electrical Specifications	12
	Electrical Specifications	12
	Electrical Specifications	12
3	Options	13
4	Dimensional drawings	14
5	Centre of gravity	15
6	Piping diagrams	16
7	Wiring diagrams	17
	Wiring Diagrams - Single Phase	17
8	Sound data	18
	Sound Power Spectrum	18
	Sound Pressure Spectrum	21

1 Features

1 - 1 CTXA-AW

- A compact and functional design suitable for all interiors in a matt crystal white finish
- The Coanda effect optimises the airflow for a comfortable climate. By using specially designed flaps, a more focused airflow allows a better temperature distribution throughout the whole room
- The grid eye sensor determines the current room temperature and distributes air evenly throughout the room before switching to an airflow pattern that directs warm or cool air to areas that need it
- Powerful air purification increases indoor air quality with Daikin Flash Streamer technology
- Practically inaudible: the unit runs so quietly, you will almost forget it is there.
- Online controller: control your indoor from any location with an app, via your local network or internet
- Choosing for an R-32 product, reduces the environmental impact with 68% compared to R-410A and leads directly to lower energy consumption thanks to its high energy efficiency
- Seasonal efficiency values up to A+++ in cooling and heating

1



- | | | | | | | | | |
|-----------------------|---------------------------------|-------------------------------------|-------------------------------|--------------|-----------------------------------|-----------------------|---------------------|-------------------|
| | | | | | | | | |
| Practically inaudible | Coanda effect - cooling | Coanda effect - heating | Grid eye sensor | Econo mode | Energy saving during standby mode | Night set mode | Fan only | Comfort mode |
| | | | | | | | | |
| Powerful mode | Auto cooling-heating changeover | Indoor unit silent operation | Outdoor unit silent operation | 3-D air flow | Vertical auto swing | Horizontal auto swing | Auto fan speed | Fan speed steps |
| | | | | | | | | |
| Dry programme | Flash Streamer | Titanium apatite deodorising filter | Air filter | Weekly timer | Infrared remote control | Wired remote control | Centralised control | Online controller |
| | | | | | | | | |
| Auto-restart | Self diagnosis | Multi model application | | | | | | |

1 Features

1 - 2 CTXA-AS

- A compact and functional design suitable for all interiors in a silver coloured elegant finish
- The Coanda effect optimises the airflow for a comfortable climate. By using specially designed flaps, a more focused airflow allows a better temperature distribution throughout the whole room
- The grid eye sensor determines the current room temperature and distributes air evenly throughout the room before switching to an airflow pattern that directs warm or cool air to areas that need it
- Powerful air purification increases indoor air quality with Daikin Flash Streamer technology
- Practically inaudible: the unit runs so quietly, you will almost forget it is there.
- Online controller: control your indoor from any location with an app, via your local network or internet
- Choosing for an R-32 product, reduces the environmental impact with 68% compared to R-410A and leads directly to lower energy consumption thanks to its high energy efficiency
- Seasonal efficiency values up to A+++ in cooling and heating



- | | | | | | | | | |
|-----------------------|---------------------------------|-------------------------------------|-------------------------------|--------------|-----------------------------------|-----------------------|---------------------|-------------------|
| | | | | | | | | |
| Practically inaudible | Coanda effect - cooling | Coanda effect - heating | Grid eye sensor | Econo mode | Energy saving during standby mode | Night set mode | Fan only | Comfort mode |
| | | | | | | | | |
| Powerful mode | Auto cooling-heating changeover | Indoor unit silent operation | Outdoor unit silent operation | 3-D air flow | Vertical auto swing | Horizontal auto swing | Auto fan speed | Fan speed steps |
| | | | | | | | | |
| Dry programme | Flash Streamer | Titanium apatite deodorising filter | Air filter | Weekly timer | Infrared remote control | Wired remote control | Centralised control | Online controller |
| | | | | | | | | |
| Auto-restart | Self diagnosis | Multi model application | | | | | | |

1 Features

1 - 3 CTXA-AT

- A compact and functional design suitable for all interiors in blackwood finish
- The Coanda effect optimises the airflow for a comfortable climate. By using specially designed flaps, a more focused airflow allows a better temperature distribution throughout the whole room
- The grid eye sensor determines the current room temperature and distributes air evenly throughout the room before switching to an airflow pattern that directs warm or cool air to areas that need it
- Powerful air purification increases indoor air quality with Daikin Flash Streamer technology
- Practically inaudible: the unit runs so quietly, you will almost forget it is there.
- Online controller: control your indoor from any location with an app, via your local network or internet
- Choosing for an R-32 product, reduces the environmental impact with 68% compared to R-410A and leads directly to lower energy consumption thanks to its high energy efficiency
- Seasonal efficiency values up to A+++ in cooling and heating

1



- | | | | | | | | | |
|-----------------------|---------------------------------|-------------------------------------|-------------------------------|--------------|-----------------------------------|-----------------------|---------------------|-------------------|
| | | | | | | | | |
| Practically inaudible | Coanda effect - cooling | Coanda effect - heating | Grid eye sensor | Econo mode | Energy saving during standby mode | Night set mode | Fan only | Comfort mode |
| | | | | | | | | |
| Powerful mode | Auto cooling-heating changeover | Indoor unit silent operation | Outdoor unit silent operation | 3-D air flow | Vertical auto swing | Horizontal auto swing | Auto fan speed | Fan speed steps |
| | | | | | | | | |
| Dry programme | Flash Streamer | Titanium apatite deodorising filter | Air filter | Weekly timer | Infrared remote control | Wired remote control | Centralised control | Online controller |
| | | | | | | | | |
| Auto-restart | Self diagnosis | Multi model application | | | | | | |

1 Features

1 - 4 FTXA-AW

- A compact and functional design suitable for all interiors in a matt crystal white finish
- The Coanda effect optimises the airflow for a comfortable climate. By using specially designed flaps, a more focused airflow allows a better temperature distribution throughout the whole room
- The grid eye sensor determines the current room temperature and distributes air evenly throughout the room before switching to an airflow pattern that directs warm or cool air to areas that need it
- Powerful air purification increases indoor air quality with Daikin Flash Streamer technology
- Practically inaudible: the unit runs so quietly, you will almost forget it is there.
- Online controller: control your indoor from any location with an app, via your local network or internet
- Choosing for an R-32 product, reduces the environmental impact with 68% compared to R-410A and leads directly to lower energy consumption thanks to its high energy efficiency
- Seasonal efficiency values up to A+++ in cooling and heating



Practically inaudible	Coanda effect - cooling	Coanda effect - heating	Grid eye sensor	Econo mode	Energy saving during standby mode	Night set mode	Fan only	Comfort mode
Powerful mode	Auto cooling-heating changeover	Indoor unit silent operation	Outdoor unit silent operation	3-D air flow	Vertical auto swing	Horizontal auto swing	Auto fan speed	Fan speed steps
Dry programme	Silver allergen removal and air purifying filter	Flash Streamer	Titanium apatite deodorising filter	Air filter	Weekly timer	Infrared remote control	Wired remote control	Centralised control
Online controller	Auto-restart	Self diagnosis	Multi model application					

1 Features

1 - 5 FTXA-AS

- A compact and functional design suitable for all interiors in a silver coloured elegant finish
- The Coanda effect optimises the airflow for a comfortable climate. By using specially designed flaps, a more focused airflow allows a better temperature distribution throughout the whole room
- The grid eye sensor determines the current room temperature and distributes air evenly throughout the room before switching to an airflow pattern that directs warm or cool air to areas that need it
- Powerful air purification increases indoor air quality with Daikin Flash Streamer technology
- Practically inaudible: the unit runs so quietly, you will almost forget it is there.
- Online controller: control your indoor from any location with an app, via your local network or internet
- Choosing for an R-32 product, reduces the environmental impact with 68% compared to R-410A and leads directly to lower energy consumption thanks to its high energy efficiency
- Seasonal efficiency values up to A+++ in cooling and heating

1



Practically inaudible	Coanda effect - cooling	Coanda effect - heating	Grid eye sensor	Econo mode	Energy saving during standby mode	Night set mode	Fan only	Comfort mode
Powerful mode	Auto cooling-heating changeover	Indoor unit silent operation	Outdoor unit silent operation	3-D air flow	Vertical auto swing	Horizontal auto swing	Auto fan speed	Fan speed steps
Dry programme	Silver allergen removal and air purifying filter	Flash Streamer	Titanium apatite deodorising filter	Air filter	Weekly timer	Infrared remote control	Wired remote control	Centralised control
Online controller	Auto-restart	Self diagnosis	Multi model application					

1 Features

1 - 6 FTXA-AT

- A compact and functional design suitable for all interiors in blackwood finish
- The Coanda effect optimises the airflow for a comfortable climate. By using specially designed flaps, a more focused airflow allows a better temperature distribution throughout the whole room
- The grid eye sensor determines the current room temperature and distributes air evenly throughout the room before switching to an airflow pattern that directs warm or cool air to areas that need it
- Powerful air purification increases indoor air quality with Daikin Flash Streamer technology
- Practically inaudible: the unit runs so quietly, you will almost forget it is there.
- Online controller: control your indoor from any location with an app, via your local network or internet
- Choosing for an R-32 product, reduces the environmental impact with 68% compared to R-410A and leads directly to lower energy consumption thanks to its high energy efficiency
- Seasonal efficiency values up to A+++ in cooling and heating



Practically inaudible	Coanda effect - cooling	Coanda effect - heating	Grid eye sensor	Econo mode	Energy saving during standby mode	Night set mode	Fan only	Comfort mode
Powerful mode	Auto cooling-heating changeover	Indoor unit silent operation	Outdoor unit silent operation	3-D air flow	Vertical auto swing	Horizontal auto swing	Auto fan speed	Fan speed steps
Dry programme	Silver allergen removal and air purifying filter	Flash Streamer	Titanium apatite deodorising filter	Air filter	Weekly timer	Infrared remote control	Wired remote control	Centralised control
Online controller	Auto-restart	Self diagnosis	Multi model application					

2 Specifications

2-1 Technical Specifications				CTXA15AW	CTXA15AS	CTXA15AT	FTXA20AW	FTXA20AS	FTXA20AT	
Power input	Cooling	Nom.	kW	0.020						
	Heating	Nom.	kW	0.020						
Casing	Colour			White	Silver	Blackwood	White	Silver	Blackwood	
Dimensions	Unit	Height/Width/Depth	mm	295/798/189						
	Packed unit	Height/Width/Depth	mm	305/875/406						
Weight	Unit			kg						
	Packed unit			kg						
Packing	Weight			kg						
Heat exchanger	Length			mm						
	Rows	Quantity								
	Fin pitch			mm						
	Face area			m ²						
	Stages	Quantity								
	Passes	Quantity								
	Tube type			ø5 Hi-XB						
	Tube material			Copper						
	Tube diameter			mm						
	Fin	Type			ML fin (Multi louver)					
Heat exchanger 2	Length			mm						
	Rows	Quantity								
	Fin pitch			mm						
	Face area			m ²						
	Stages	Quantity								
Air filter	Type			Removable / washable						
	Quantity			pc						
Fan	Type			Cross flow fan						
	Quantity			1						
	Air flow rate	Cooling	High	m ³ /min	11.0					
				cfm	388					
			Medium	m ³ /min	8					
				cfm	290					
			Low	m ³ /min	6.1					
				cfm	215					
		Silent operation	m ³ /min	4.6						
			cfm	162						
		Heating	High	m ³ /min	10.9					
				cfm	385					
			Medium	m ³ /min	8.7					
cfm				307						
Low	m ³ /min		6.4							
	cfm		226							
Silent operation	m ³ /min	4.5								
	cfm	159								
Fan motor	Quantity			1						
	Model			MM9G07N9SA						
	Speed	Cooling	High/ Medium/Low/Silent operation	rpm	1,100/870/690/570					
			Heating	High/ Medium/Low/Silent operation	rpm	1,090/920/740/590				

2 Specifications

2-1 Technical Specifications				CTXA15AW	CTXA15AS	CTXA15AT	FTXA20AW	FTXA20AS	FTXA20AT
Sound power level	Cooling		dBA	57					
Sound pressure level	Cooling	High/Medium/Low/Silent operation	dBA	39/32/25/21			39/32/25/19		
	Heating	High/Medium/Low/Silent operation	dBA	39/32/25/21			39/32/25/19		
Control systems	Infrared remote control		ARC466A58						
	Wired remote control		BRC073						
Refrigerant	Type		R-32						
	GWP		675.0						
Piping connections	Liquid	OD	6,35						
	Gas	OD	9.50						
	Drain		18						
	Heat insulation		Both liquid and gas pipes						
Temperature control			Microcomputer control						
Air direction control			Right, Left, Horizontal, Downward						

Standard Accessories : Installation manual; Quantity : 1;

Standard Accessories : Operation manual; Quantity : 1;

Standard Accessories : Air filter; Quantity : 2;

Standard Accessories : Infrared remote control; Quantity : 1;

Standard Accessories : Remote controller mounting plate; Quantity : 1;

Standard Accessories : Screw bag; Quantity : 1;

Standard Accessories : Screw cover; Quantity : 1;

Standard Accessories : AAA dry-cell batteries; Quantity : 2;

Standard Accessories : General safety precautions; Quantity : 1;

2-2 Technical Specifications				FTXA25AW	FTXA25AS	FTXA25AT	FTXA35AW	FTXA35AS	FTXA35AT	
Power input	Cooling	Nom.	kW	0.022			0.023			
	Heating	Nom.	kW	0.020			0.022			
Casing	Colour			White	Silver	Blackwood	White	Silver	Blackwood	
Dimensions	Unit	Height/Width/Depth	mm	295/798/189						
	Packed unit	Height/Width/Depth	mm	305/875/406						
Weight	Unit		kg	12						
	Packed unit		kg	14						
Packing	Weight		kg	3						
Heat exchanger	Length		mm	622						
	Rows	Quantity		2						
	Fin pitch		mm	1.40						
	Face area		m ²	0.214						
	Stages	Quantity		18						
	Passes	Quantity		3						
	Tube type		ø5 Hi-XB							
	Tube material		Copper							
	Tube diameter		mm	5						
	Fin	Type		ML fin (Multi louver)						
Heat exchanger 2	Length		mm	614						
	Rows	Quantity		1						
	Fin pitch		mm	1.40						
	Face area		m ²	0.047						
	Stages	Quantity		4						
Air filter	Type		Removable / washable							
	Quantity		pc	2						

2 Specifications

2-2 Technical Specifications				FTXA25AW	FTXA25AS	FTXA25AT	FTXA35AW	FTXA35AS	FTXA35AT	
Fan	Type			Cross flow fan						
	Quantity			1						
	Air flow rate	Cooling	High	m ³ /min	11.5		11.9			
				cfm	406		420			
			Medium	m ³ /min	9					
				cfm	304					
			Low	m ³ /min	6.1					
				cfm	215					
		Silent operation	m ³ /min	4.6						
			cfm	162						
		Heating	High	m ³ /min	11.1		11.5			
				cfm	392		406			
			Medium	m ³ /min	9.0					
				cfm	318					
Low	m ³ /min		6.4							
	cfm		226							
Silent operation	m ³ /min	4.5								
	cfm	159								
Fan motor	Quantity			1						
	Model			MM9G07N9SA						
	Speed	Cooling	High/ Medium/Low/Silent operation	rpm	1,140/900/690/570		1,180/900/690/570			
			Heating	High/ Medium/Low/Silent operation	rpm	1,110/940/740/590		1,140/940/740/590		
Sound power level	Cooling		dB(A)	57		60				
Sound pressure level	Cooling	High/Medium/Low/Silent operation	dB(A)	40/33/25/19		41/33/25/19				
	Heating	High/Medium/Low/Silent operation	dB(A)	40/33/25/19		41/33/25/19				
Control systems	Infrared remote control			ARC466A58						
	Wired remote control			BRC073						
Refrigerant	Type			R-32						
	GWP			675.0						
Piping connections	Liquid			-						
	Gas			-						
Drain				18						
Heat insulation				Both liquid and gas pipes						
Temperature control				Microcomputer control						
Air direction control				Right, Left, Horizontal, Downward						

- Standard Accessories : Installation manual; Quantity : 1;
- Standard Accessories : Operation manual; Quantity : 1;
- Standard Accessories : Air filter; Quantity : 2;
- Standard Accessories : Infrared remote control; Quantity : 1;
- Standard Accessories : Remote controller mounting plate; Quantity : 1;
- Standard Accessories : Screw bag; Quantity : 1;
- Standard Accessories : Screw cover; Quantity : 1;
- Standard Accessories : AAA dry-cell batteries; Quantity : 2;
- Standard Accessories : General safety precautions; Quantity : 1;

2 Specifications

2-3 Technical Specifications				FTXA42AW	FTXA42AS	FTXA42AT	FTXA50AW	FTXA50AS	FTXA50AT	
Power input	Cooling	Nom.	kW	0.028			0.030			
	Heating	Nom.	kW	0.036			0.039			
Casing	Colour			White	Silver	Blackwood	White	Silver	Blackwood	
Dimensions	Unit	Height/Width/Depth	mm	295/798/189						
	Packed unit	Height/Width/Depth	mm	305/875/406						
Weight	Unit		kg	12						
	Packed unit		kg	14						
Packing	Weight		kg	3						
Heat exchanger	Length		mm	622						
	Rows	Quantity		2						
	Fin pitch		mm	1.40						
	Face area		m ²	0.214						
	Stages	Quantity		18						
	Passes	Quantity		3						
	Tube type		ø5 Hi-XB							
	Tube material		Copper							
	Tube diameter		mm	5						
	Fin	Type		ML fin (Multi louver)						
	Heat exchanger 2	Length		mm	614					
Rows		Quantity		1						
Fin pitch		mm	1.40							
Face area		m ²	0.047							
Stages		Quantity		4						
Air filter	Type			Removable / washable						
	Quantity		pc	2						
Fan	Type			Cross flow fan						
	Quantity			1						
	Air flow rate	Cooling	High	m ³ /min	13.1			13.5		
				cfm	463			477		
			Medium	10						
				cfm	346			367		
			Low	m ³ /min	7.2			7.6		
				cfm	254			268		
		Silent operation	m ³ /min	4.6			5.2			
			cfm	162			184			
		Heating	High	m ³ /min	14.6			15.1		
				cfm	516			533		
			Medium	m ³ /min	10.5			11.1		
				cfm	371			392		
Low	m ³ /min		7.7			8.2				
	cfm		272			290				
Silent operation	m ³ /min	5.2			5.7					
	cfm	184			201					
Fan motor	Quantity			1						
	Model			MM9G07N9SA						
	Speed	Cooling	High/Medium/Low/Silent operation	rpm	1,210/980/780/570			1,240/1,020/820/620		
				rpm	1,310/1,070/850/640			1,350/1,190/930/680		

2 Specifications

2

2-3 Technical Specifications				FTXA42AW	FTXA42AS	FTXA42AT	FTXA50AW	FTXA50AS	FTXA50AT
Sound power level	Cooling		dBA	60					
Sound pressure level	Cooling	High/Medium/Low/Silent operation	dBA	45/37/29/21			46/39/31/24		
	Heating	High/Medium/Low/Silent operation	dBA	45/37/29/21			46/42/33/24		
Control systems	Infrared remote control		ARC466A58						
	Wired remote control		BRC073						
Refrigerant	Type		R-32						
	GWP		675.0						
Piping connections	Liquid		-						
	Gas		-						
Drain			18						
Heat insulation			Both liquid and gas pipes						
Temperature control			Microcomputer control						
Air direction control			Right, Left, Horizontal, Downward						

Standard Accessories : Installation manual; Quantity : 1;

Standard Accessories : Operation manual; Quantity : 1;

Standard Accessories : Air filter; Quantity : 2;

Standard Accessories : Infrared remote control; Quantity : 1;

Standard Accessories : Remote controller mounting plate; Quantity : 1;

Standard Accessories : Screw bag; Quantity : 1;

Standard Accessories : Screw cover; Quantity : 1;

Standard Accessories : AAA dry-cell batteries; Quantity : 2;

Standard Accessories : General safety precautions; Quantity : 1;

2-4 Electrical Specifications				CTXA15AW	CTXA15AS	CTXA15AT	FTXA20AW	FTXA20AS	FTXA20AT
Power supply	Name		V1						
	Phase		1~						
	Frequency	Hz	50						
	Voltage	V	220-240						
Current	Nominal running current (RLA) - 50Hz	Cooling	A	0.3					
		Heating	A	0.3					
Wiring connections - 50Hz	For power supply	Quantity	3						
		Remark	3 for power supply, 4 for interunit wiring (Earth wire included)						

2-5 Electrical Specifications				FTXA25AW	FTXA25AS	FTXA25AT	FTXA35AW	FTXA35AS	FTXA35AT
Power supply	Name		V1						
	Phase		1~						
	Frequency	Hz	50						
	Voltage	V	220-240						
Current	Nominal running current (RLA) - 50Hz	Cooling	A	0.4					
		Heating	A	0.4					
Wiring connections - 50Hz	For power supply	Quantity	3						
		Remark	3 for power supply, 4 for interunit wiring (Earth wire included)						

2-6 Electrical Specifications				FTXA42AW	FTXA42AS	FTXA42AT	FTXA50AW	FTXA50AS	FTXA50AT
Power supply	Name		V1						
	Phase		1~						
	Frequency	Hz	50						
	Voltage	V	220-240						
Current	Nominal running current (RLA) - 50Hz	Cooling	A	0.5					
		Heating	A	0.6					
Wiring connections - 50Hz	For power supply	Quantity	3						
		Remark	3 for power supply, 4 for interunit wiring (Earth wire included)						

3 Options

3 - 1 Options

CTXA-AS_AT_AW
FTXA-AS_AT_AW

Applicable models	Class	Casing	Factory
CTXA15A2V1BW	15	STYLISH	DiCz
CTXA15A2V1BS	15	STYLISH	DiCz
CTXA15A2V1BT	15	STYLISH	DiCz
FTXA20A2V1BW	20	STYLISH	DiCz
FTXA20A2V1BS	20	STYLISH	DiCz
FTXA20A2V1BT	20	STYLISH	DiCz
FTXA25A2V1BW	25	STYLISH	DiCz
FTXA25A2V1BS	25	STYLISH	DiCz
FTXA25A2V1BT	25	STYLISH	DiCz
FTXA35A2V1BW	35	STYLISH	DiCz
FTXA35A2V1BS	35	STYLISH	DiCz
FTXA35A2V1BT	35	STYLISH	DiCz
FTXA42A2V1BW	42	STYLISH	DiCz
FTXA42A2V1BS	42	STYLISH	DiCz
FTXA42A2V1BT	42	STYLISH	DiCz
FTXA50A2V1BW	50	STYLISH	DiCz
FTXA50A2V1BS	50	STYLISH	DiCz
FTXA50A2V1BT	50	STYLISH	DiCz

Option kit	Product name	Remark	CTXA15A2V1BW	CTXA15A2V1BS	CTXA15A2V1BT	FTXA20A2V1BW	FTXA20A2V1BS	FTXA20A2V1BT	FTXA25A2V1BW	FTXA25A2V1BS	FTXA25A2V1BT	FTXA35A2V1BW	FTXA35A2V1BS	FTXA35A2V1BT	FTXA42A2V1BW	FTXA42A2V1BS	FTXA42A2V1BT	FTXA50A2V1BW	FTXA50A2V1BS	FTXA50A2V1BT	
Wired remote control	BRC073A4	② ③	✓	✓	✓	✓	✓	✓	✓	✓	✓	✓	✓	✓	✓	✓	✓	✓	✓	✓	✓
Extension cord for wired remote control (3m)	BRCW901A03		✓	✓	✓	✓	✓	✓	✓	✓	✓	✓	✓	✓	✓	✓	✓	✓	✓	✓	✓
Extension cord for wired remote control (8m)	BRCW901A08		✓	✓	✓	✓	✓	✓	✓	✓	✓	✓	✓	✓	✓	✓	✓	✓	✓	✓	✓
Interface adaptor for DIII-NET	KRP928BA25	② ③	✓	✓	✓	✓	✓	✓	✓	✓	✓	✓	✓	✓	✓	✓	✓	✓	✓	✓	✓
Central remote control	DCS302CA51	② ③	✓	✓	✓	✓	✓	✓	✓	✓	✓	✓	✓	✓	✓	✓	✓	✓	✓	✓	✓
Schedule timer	DST301BA51	② ③	✓	✓	✓	✓	✓	✓	✓	✓	✓	✓	✓	✓	✓	✓	✓	✓	✓	✓	✓
Unified ON/OFF controller	DCS301BS1	② ③	✓	✓	✓	✓	✓	✓	✓	✓	✓	✓	✓	✓	✓	✓	✓	✓	✓	✓	✓
Wiring adaptor (normal open contact - normal open pulse contact)	KRP413A15	② ③	✓	✓	✓	✓	✓	✓	✓	✓	✓	✓	✓	✓	✓	✓	✓	✓	✓	✓	✓
Conversion wire harness	EKRS21	②	✓	✓	✓	✓	✓	✓	✓	✓	✓	✓	✓	✓	✓	✓	✓	✓	✓	✓	✓
Anti-theft protection for remote control	KKF910A4		✓	✓	✓	✓	✓	✓	✓	✓	✓	✓	✓	✓	✓	✓	✓	✓	✓	✓	✓
KNX interface	KLIC-DD	② ③	✓	✓	✓	✓	✓	✓	✓	✓	✓	✓	✓	✓	✓	✓	✓	✓	✓	✓	✓
Titanium apatite deodorising filter without frame	KAF970A46	①	✓	✓	✓	✓	✓	✓	✓	✓	✓	✓	✓	✓	✓	✓	✓	✓	✓	✓	✓
Silver particle filter (Ag-ion) with frame	KAF057A41	①	✓	✓	✓	✓	✓	✓	✓	✓	✓	✓	✓	✓	✓	✓	✓	✓	✓	✓	✓

Notes

- Standard accessory
- This option features a(n) S21 connector. To connect this option to the indoor unit, therefore conversion wire harness EKRS21 is required.
- This option cannot operate together with the wireless LAN functionality that is a standard feature of the indoor unit.
When connecting this option to the indoor unit, turn off the indoor unit's wireless LAN functionality.

3D114991

6 Piping diagrams

6 - 1 Piping Diagrams

6

CTXA-AW/AS/AT
FTXA-AW/AS/AT

Indoor unit

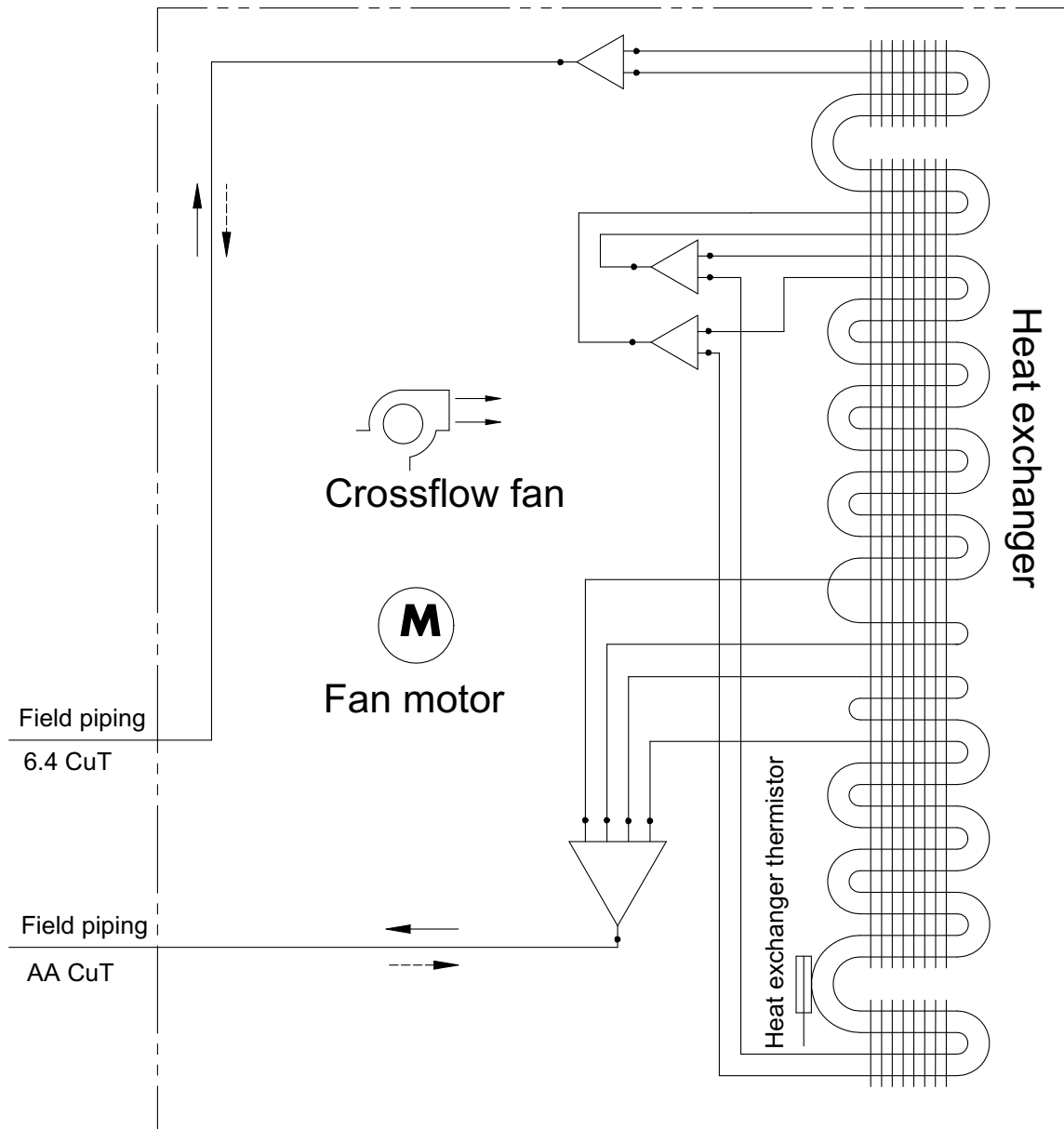

Refrigerant flow

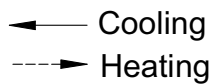

Distributor

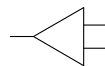

Gas header

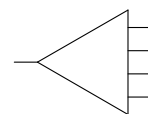

AA	Class
9.5	15~35
12.7	42~50

4D113514

8 Sound data

8 - 1 Sound Power Spectrum

8

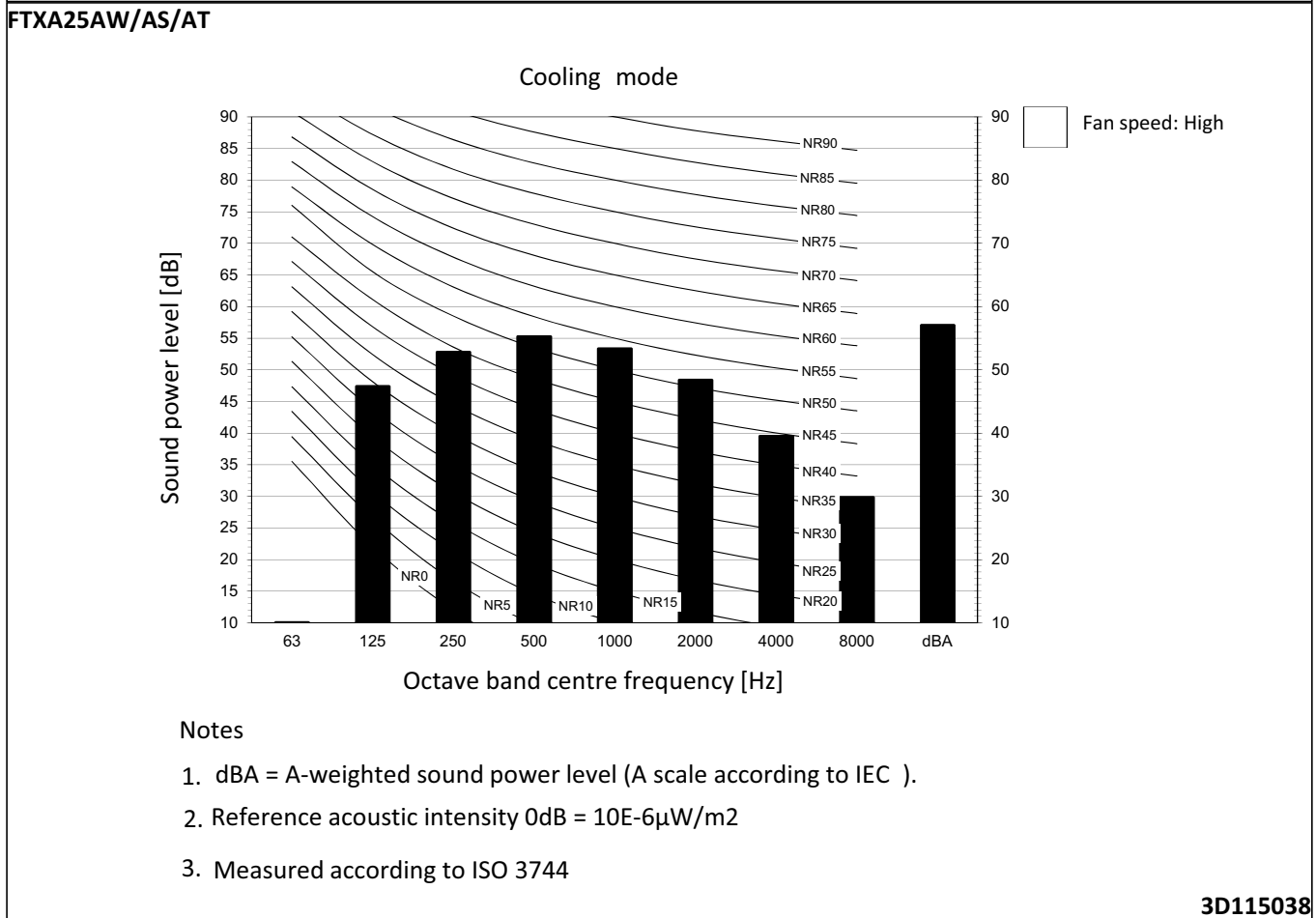
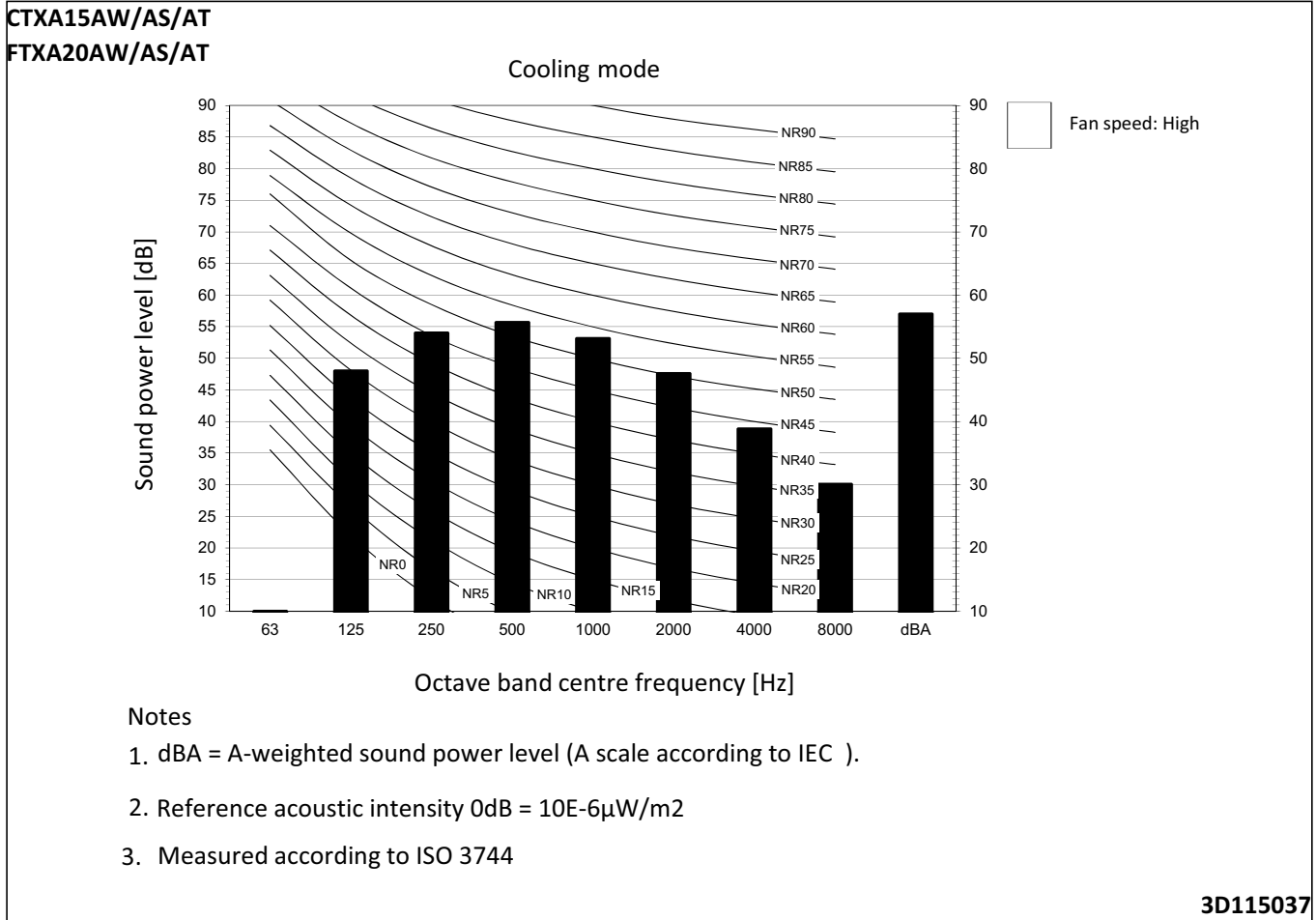

8 Sound data

8 - 1 Sound Power Spectrum

8

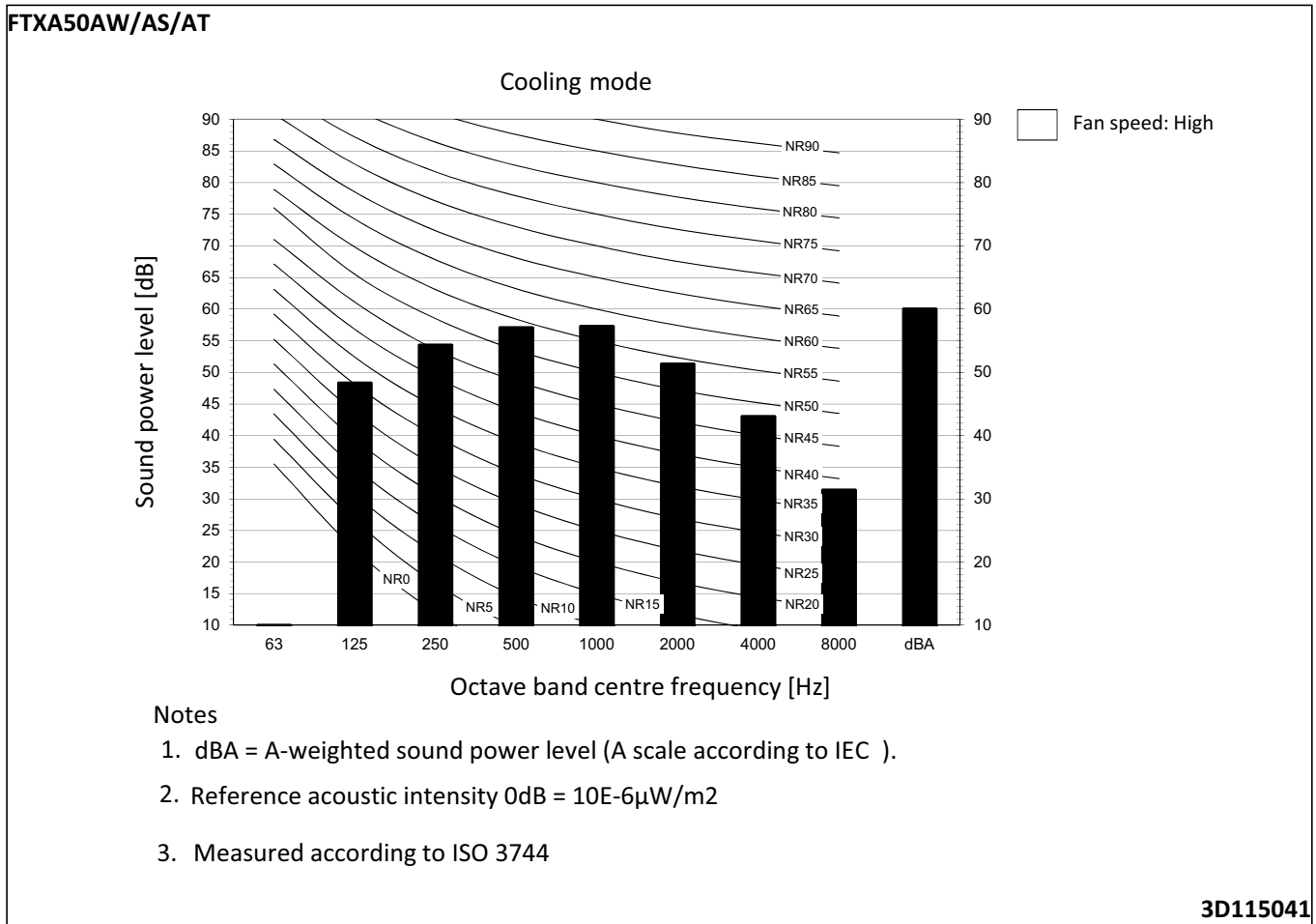

8 Sound data

8 - 2 Sound Pressure Spectrum

8

FTXA25AW/AS/AT

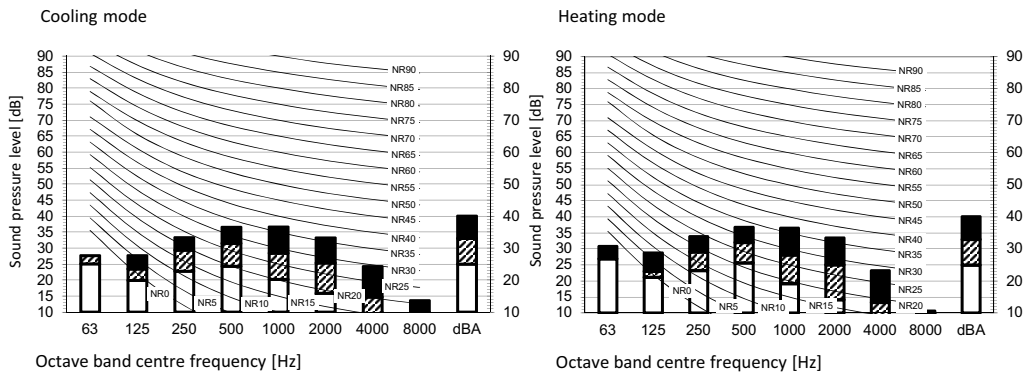

Legend

dBA = A-weighted sound pressure level (A scale according to IEC).

- A Scale
- B Fan speed: High
- C Fan speed: Medium
- D Fan speed: Low

Cooling				Heating			
Total dB				Total dB			
A	B	C	D	A	B	C	D
dBA	40	33	25	dBA	40	33	25

Notes

Location of microphone

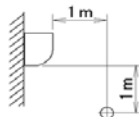

- Operating conditions: power source 220-240 V/220 V 50/60 Hz; JIS standard
- Background noise already taken into account.
- Operating noise varies depending on operation and ambient conditions.
- The operation noise measuring method is in accordance with JISC 9612.
- Measuring location: anechoic chamber

3D114920

FTXA35AW/AS/AT

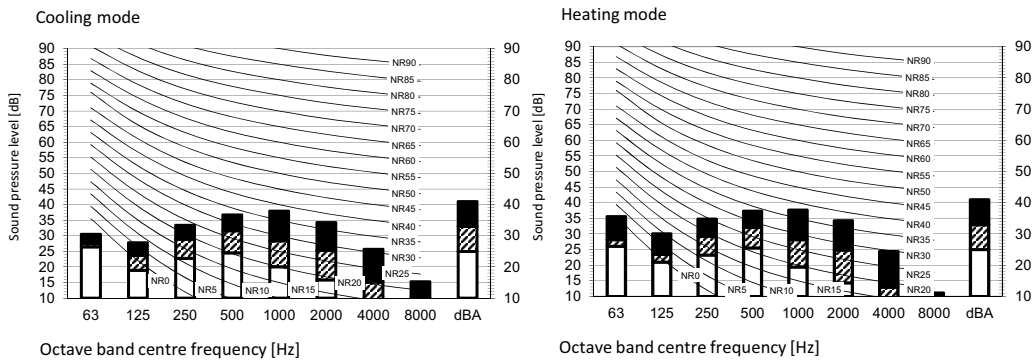

Legend

dBA = A-weighted sound pressure level (A scale according to IEC).

- A Scale
- B Fan speed: High
- C Fan speed: Medium
- D Fan speed: Low

Cooling				Heating			
Total dB				Total dB			
A	B	C	D	A	B	C	D
dBA	41	33	25	dBA	41	33	25

Notes

Location of microphone

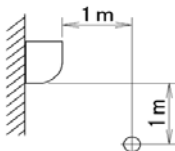

- Operating conditions: power source 220-240 V/220 V 50/60 Hz; JIS standard
- Background noise already taken into account.
- Operating noise varies depending on operation and ambient conditions.
- The operation noise measuring method is in accordance with JISC 9612.
- Measuring location: anechoic chamber

3D114921



Daikin Europe N.V. Naamloze Vennootschap - Zandvoordestraat 300, B-8400 Oostende - Belgium - www.daikin.eu - BE 0412 120 336 - RPR Oostende

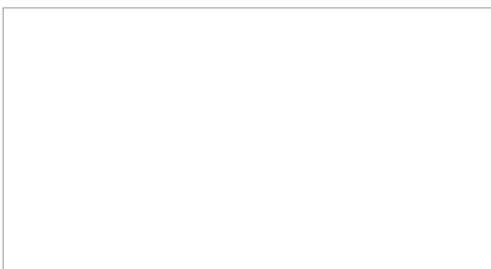

EEDEN18 06/18



Daikin Europe N.V. participates in the Eurovent Certified Performance programme for Liquid Chilling Packages and Hydronic Heat Pumps, Fan Coil Units and Variable Refrigerant Flow systems. Check ongoing validity of certificate: www.eurovent-certification.com



The present leaflet is drawn up by way of information only and does not constitute an offer binding upon Daikin Europe N.V.. Daikin Europe N.V. has compiled the content of this leaflet to the best of its knowledge. No express or implied warranty is given for the completeness, accuracy, reliability or fitness for particular purpose of its content and the products and services presented therein. Specifications are subject to change without prior notice. Daikin Europe N.V. explicitly rejects any liability for any direct or indirect damage, in the broadest sense, arising from or related to the use and/or interpretation of this leaflet. All content is copyrighted by Daikin Europe N.V.